

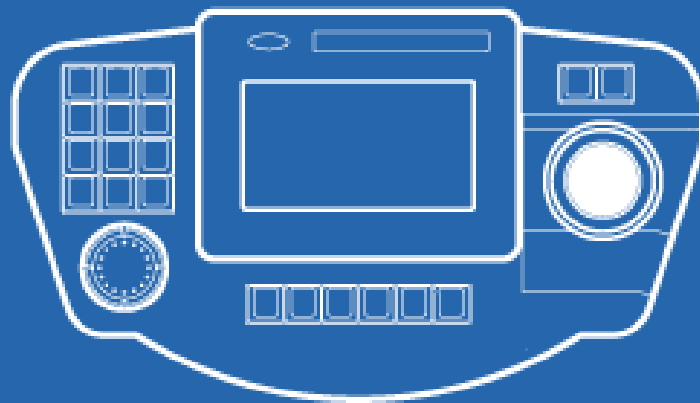

# CONTROL KEYBOARD

USER MANUAL

## DCK-500A









# CONTENTS

<b>1. Caution before installation</b>	<b>3</b>
<b>2. Features &amp; Distinctions</b>	<b>5</b>
1). COMPONENTS	5
2). Summary & Features	6
3). Keyboard Functional Keys	7
4). JUNCTION BOX	9
<b>3. How to Use in Detail</b>	<b>10</b>
1). Basic Connection	10
2). How to set at Beginning	11
3). CONTROL MODE Setup	20
1. PTZ CONTROL MODE Setup and Functions	22
2. Setup for MATRIX CONTROL Mode	28
3. Setup for DVR CONTROL Mode	30
4). Other Detailed Functions	32
5). OSD Setup Mode	32
6). Other Setup Mode	33
<b>4. More Cautions and Check Points</b>	<b>37</b>
<b>5. Dimensions</b>	<b>39</b>
<b>6. SYSTEM Configuration</b>	<b>40</b>
<b>7. General Specifications</b>	<b>42</b>
<b>8. Quick Reference</b>	<b>44</b>

## 1. Caution before installation

Thank you very much for having D-max keyboard. You are strongly required to study this manual before installation. Facing problem or something you don't understand while using, please consult with your systems installers or service personnel.



### Caution before Installation.

Install the unit after you read following advice. Avoid installing in places as below,	
	<ul style="list-style-type: none"><li>□ <b>Places with too much high or low temperatures</b><ul style="list-style-type: none"><li>● Extreme temperatures will damage the unit.</li><li>● Always use it within the recommended temperature range of 0°C to 40°C</li></ul></li></ul>
	<ul style="list-style-type: none"><li>□ <b>Where there are excessive dust, smoke, moisture or humidity.</b><ul style="list-style-type: none"><li>● Using this appliance under such conditions may result in fire, electrical shock or other serious damage</li></ul></li></ul>
	<ul style="list-style-type: none"><li>□ <b>Where the unit can be blended with all kinds of oil or gas</b><ul style="list-style-type: none"><li>● It may cause the problem if you expose in those conditions.</li></ul></li></ul>
	<ul style="list-style-type: none"><li>□ <b>Places with vibration or impact</b><ul style="list-style-type: none"><li>● Excessive shock may damage the appliance</li></ul></li></ul>
	<ul style="list-style-type: none"><li>□ <b>Do not place the appliance in direct sunlight</b><ul style="list-style-type: none"><li>● It may discolor the unit or cause a problem.</li></ul></li></ul>
	<ul style="list-style-type: none"><li>□ <b>Places with high frequency waves, power cables</b><ul style="list-style-type: none"><li>● Using the appliance under conditions such as electromagnetic waves cause a problem.</li></ul></li></ul>

## Caution in use

Install the unit after you read following advice.

Avoid following acts,

	<ul style="list-style-type: none"><li>□ <b>Do not try to disassemble the appliance or put any foreign element.</b><ul style="list-style-type: none"><li>● It may cause a problem.</li></ul></li></ul>
	<ul style="list-style-type: none"><li>□ <b>Turn the power off before installation.</b><ul style="list-style-type: none"><li>● Before you install the unit, please check the power voltage and turn the switch on.</li></ul></li></ul>
	<ul style="list-style-type: none"><li>□ <b>Never have the unit impacted or operated.</b><ul style="list-style-type: none"><li>● If you expose the unit to the strong impact or if the button or terminal are forced to operate, it will be damaged. (Be careful in using the joystick in particular, if you put too much power on it while moving left, right or zoom, it may be damaged)</li></ul></li></ul>



This product has been designed and manufactured in accordance with the harmonized European standards, following the provisions of the below stated directives.

Electromagnetic Compatibility Directive 89/336/EEC(EN61000-3-2:1995, EN61000-3-3:1995, EN50081-1:1992, EN50082-1:1997)

This device complies with part 15 of the fcc rules operation is subject to the following two conditions: (1) This device may not cause harmful interference and (2) This device must accept any interference received including interference that may cause undesired operation

# 2. Features & Distinctions

## 1). COMPONENTS

- ① Body of the Keyboard + Touch pen

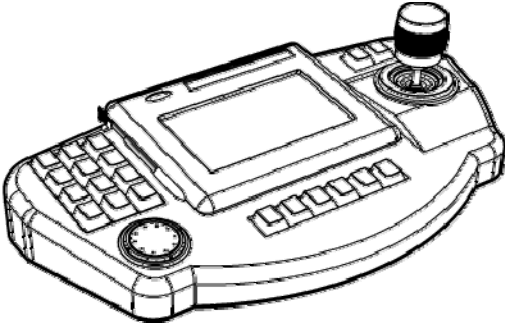

- ② Data Box (Junction Box)

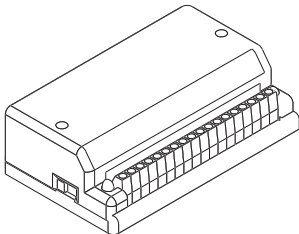

- ③ Connector Cable (Modular jack)



- ④ User Manual

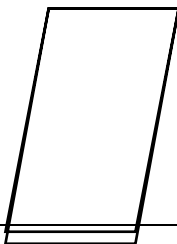

## 2). Summary & Features

### 1. Summary

This unit is a multiple CCTV control keyboard enables to control Speed Dome Camera, CCTV Receiver, Matrix System, DVR, Quad and so on. You can set up a variety of functions of the speed dome camera and make efficient use of the dome camera for better surveillance by gearing all kinds of sensors.

This appliance can be used as a Matrix main(sub) keyboard, CCTV Transmitter main(sub) keyboard at user's option.

This manual is explaining only about controlling CCTV Transmitter, please refer to the matrix manual for the detailed use of D-MAX Matrix system.

### 2. Features

- Locking monitor and camera control.
- Convenient control by 5.5 Inch Touch Screen
- Controls up to 512 cameras.
- Controls maximum 32 monitors (when connecting with matrix, DMX-25632)
- Controls maximum 64 DVR
- Pan/ Tilt/ Zoom controlled by 3-axis joystick.
- Max. 500 Preset widens the surveillance area.
- PAN/ TILT Swing (Auto Pan)
- 12 Group-Tour
- Set and Run the Tour
- Set and Run PTZ Trace.
- Set up on OSD menu of the camera.
- Set and Run Spiral.
- Gearing with alarm receiver unit(controls 512 Sensors)
- Controls DVR with Jog-shuttle (Soon be developed)
- Remote control from Remote Controller
- Users with password only can set up the function.

### 3). Keyboard Functional Keys

#### 1. Upper Section

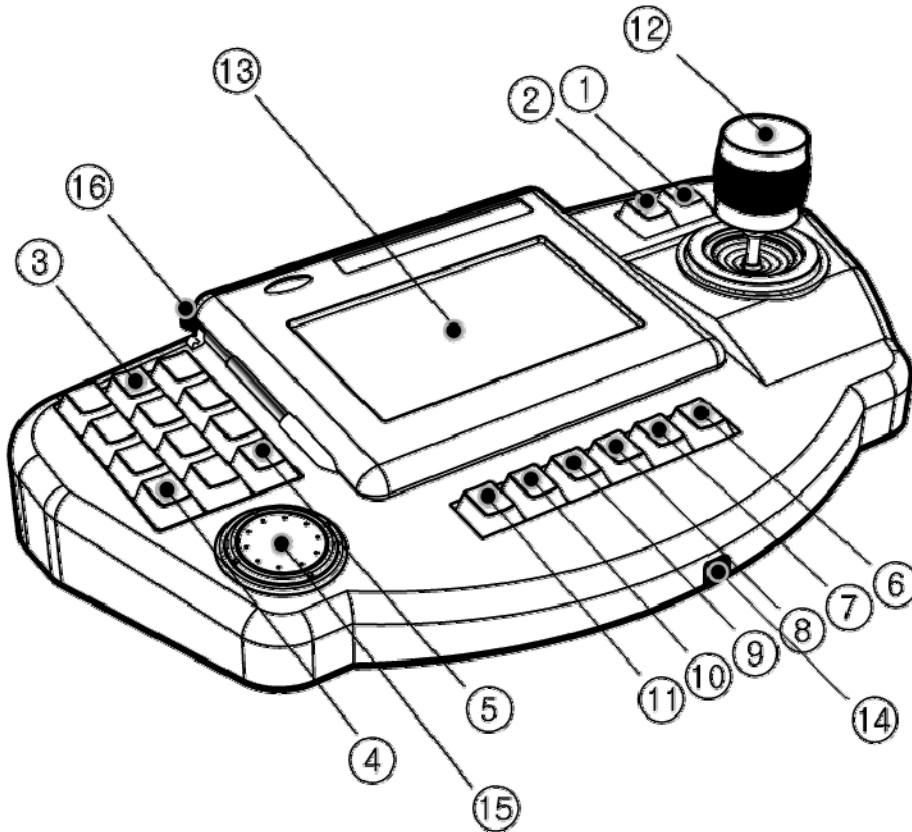

1), 2) F/N, F/F : controls focus while using Zoom lens

3) Numeric keypad: used to input numerical value or other functions

4) CLR(CLEAR): Used to cancel input command or number.

5) ENT(ENTER) : press this key to input command or save, run designated commands

6) SET : Use this key for camera Setup or Keyboard User's Setup Mode.

7) P-SET : Used to set "PRESET". Please study explanation of each section for more detailed function.

8) ALARM : activate or release the alarm when gearing dome camera with ARU (alarm receiver unit)

9) DVR : Press this key to enter "DVR Control Mode" or select DVR by using numeric key together.

10) MON: Selects monitor

11) CAM : Selects camera

12) Joystick : helps you control the camera up/ down, left/ right, zoom in/ out

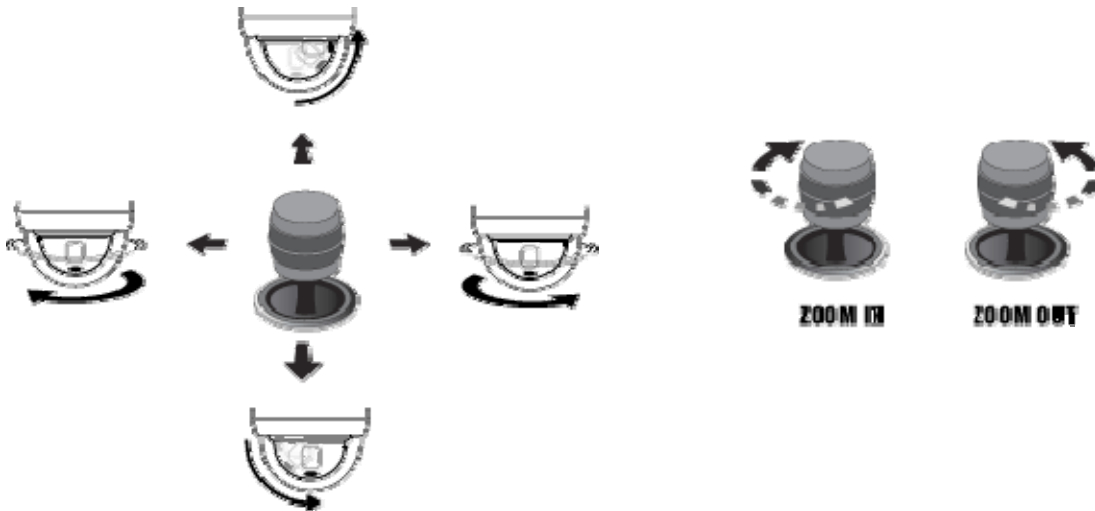

- 13) Color LCD(Screen): It has many different buttons for each function and supports real time Video.
- 14) Sensor: allows to remotely control keyboard with remote controller (soon be released)
- 15) Jog-shuttle: controls DVR
- 16) Touch-Pen: Used to touch the LCD screen and run functions.

2. Rear Section

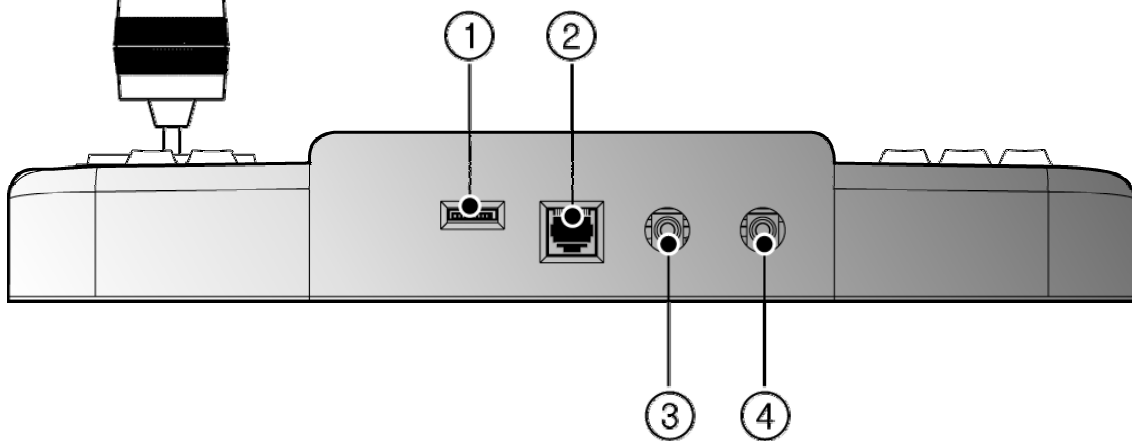

- 1) Connector for update: Used to upgrade the keyboard when needed.
- 2) RJ-45 Connector: Connection Terminal for Junction Box which comes together with the Keyboard.
- 3),4) VIDEO Input Connector: Input Terminal used to input 2 videos (CH1, CH2)



#### 4). Data Box (Junction box)

Set the communication mode to either RS-485 or RS-422 at your option.

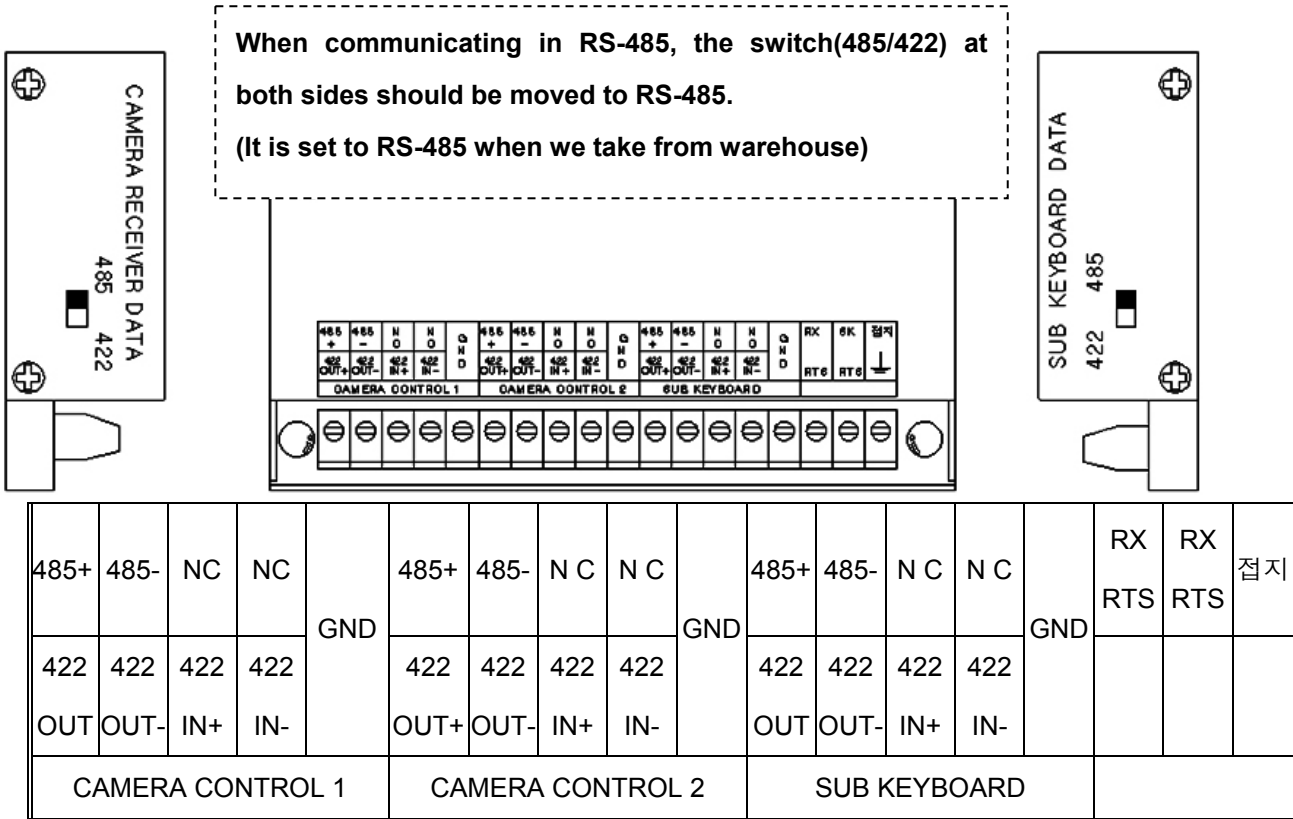

#### INPUT/OUTPUT TERMINAL OF DATA JUNCTION BOX

Camera controls 1: This is the terminal that you can connect with up to 128 speed dome cameras or receivers.

(Choose either 485 or 422 communication mode and connect in parallel)

Camera controls 2: this is the terminal that you can connect with up to 128 speed dome cameras or receivers.

(Choose either 485 or 422 communication mode and connect in parallel)

**(All together, 256 cameras can be controlled as above connection)**

Sub keyboard : This is the terminal that you can connect sub-keyboard with when hoping to use sub-keyboard and it does duplex transmission.

(Parallel connection is available when using RS485, but if you use RS422 only 1:1 connection is available.)

### 3. How to Use in Detail

#### 1). Basic Connection

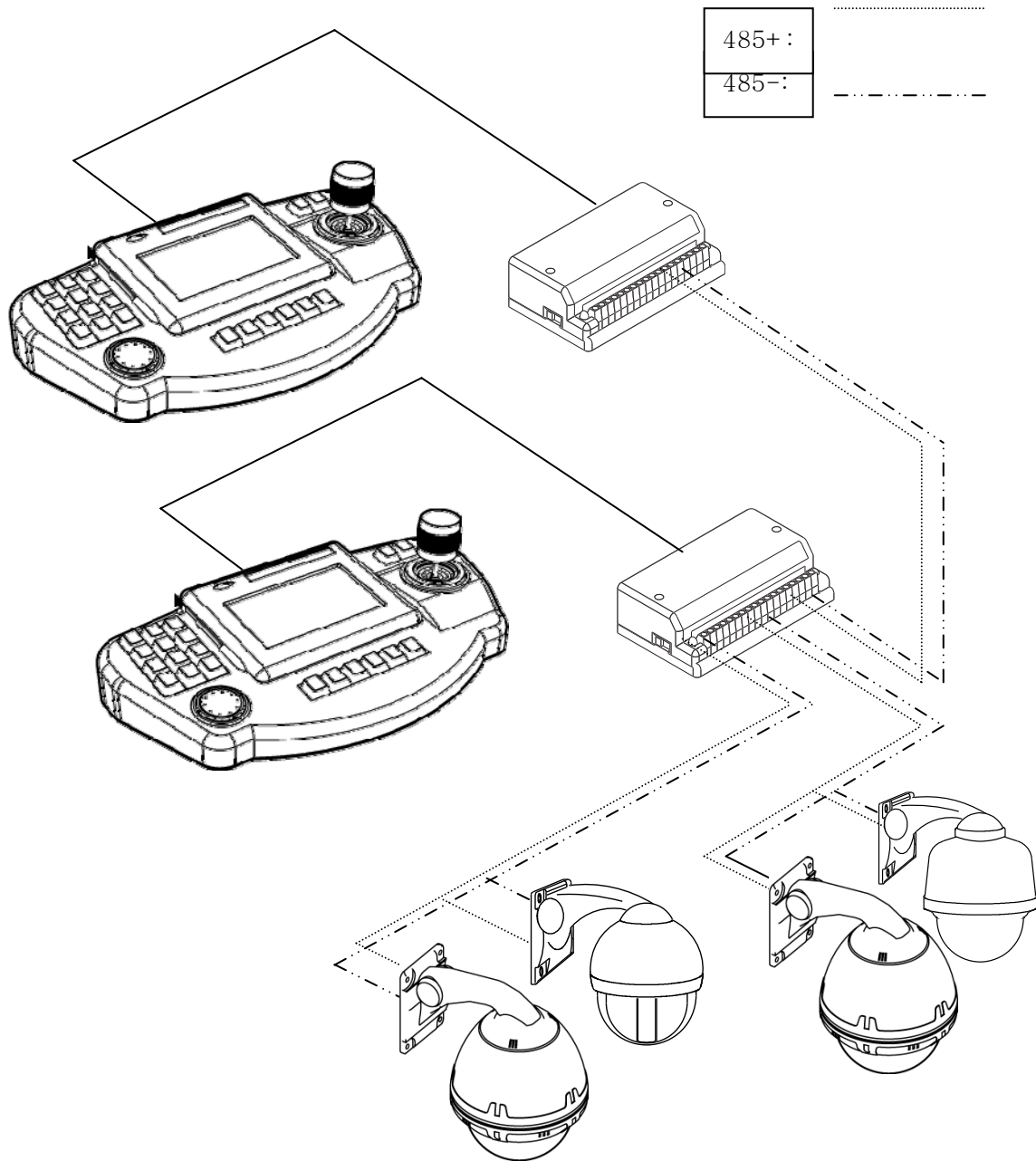

3 lines (485+, 485-, GND) can be used for data line.

(Ground could be of help when earth is stable, but normally 485+, 485- can be used for data connection)

## 2). How to set at Beginning

– If the Power is given to the Unit, below picture will appear.

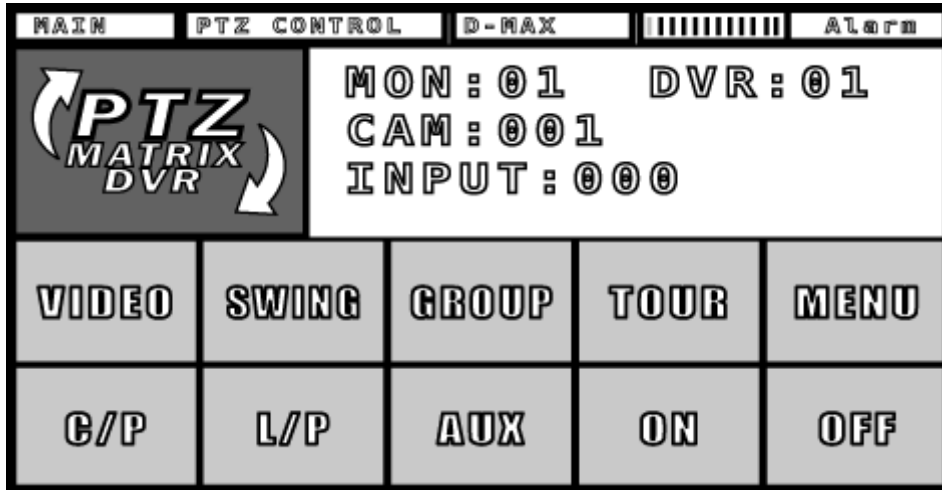

### 1. Factory Default

- MAIN Keyboard
- PTZ Control mode
- Protocol : D-max 9600
- Mon:01/DVR:01/Cam:001

### 2. Setting the 'SETUP Mode'

On this mode, Main/ Sub Keyboard can be selected and communication setup of camera or monitor can be set and Password Setup can be made.

- ① Hold the  key for 3 seconds and blank for password input will appear on the LCD as below,

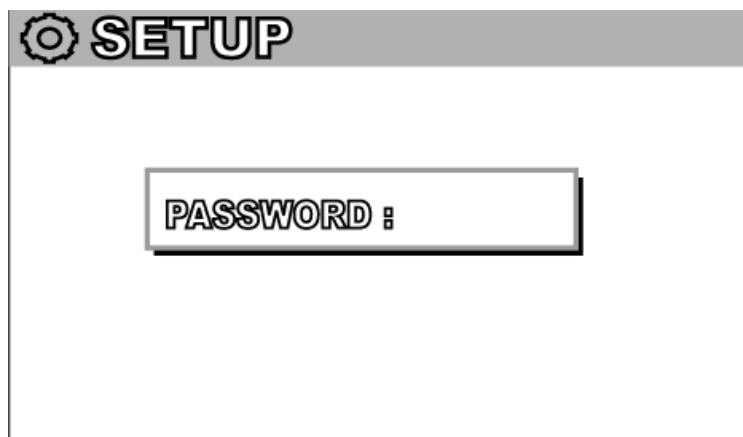

- ② Input PASSWORD.

(Default is 0000)







③ If password is input, Setup mode will show up.

### ① SET CAMERA

Setup for communication and usage of camera connected to this unit can be set here.

① Move the Joystick to “SET CAMERA”.

② Press  key to enter Setup Mode.

③ Move the Joystick  up/down, left/right and set by turning upper Joystick.  

- ◆ Max. 512 cameras set can be made..
- ◆ If you would like to move quickly to next page, do not flick the Joystick, just keep the Joystick down or up and stay.

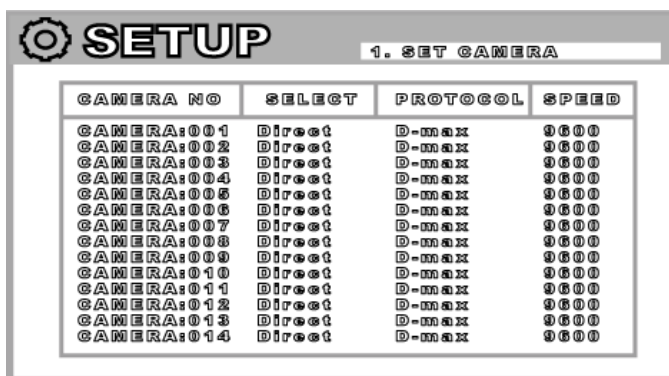



#### • SELECT CAMERA

- Direct: Choose this when PTZ camera is directly connected to keyboard or Matrix..
- DVR mode: Select this mode when PTZ Camera is connected to DVR.
- Disable: It is used to lock the camera so It can not be controlled.

#### • PROTOCOL/SPEED

- D-max, Pelco-P, Pelco-D, Samsung / 9600, 4800, 2400bps can be chosen.

④ Press  to escape to the previous menu, press  to finish the setup mode after save.

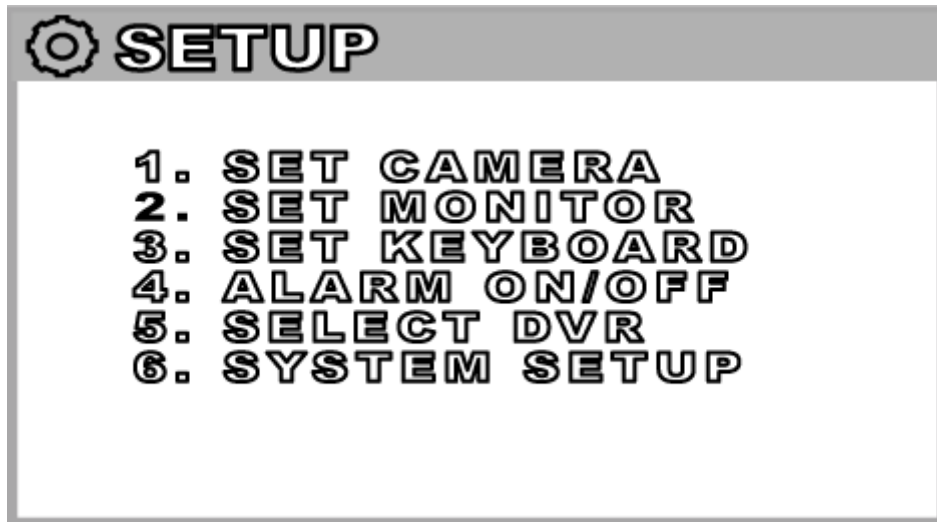

## ② MONITOR Setup

You can set the Monitors here and make it useful or useless from this keyboard.

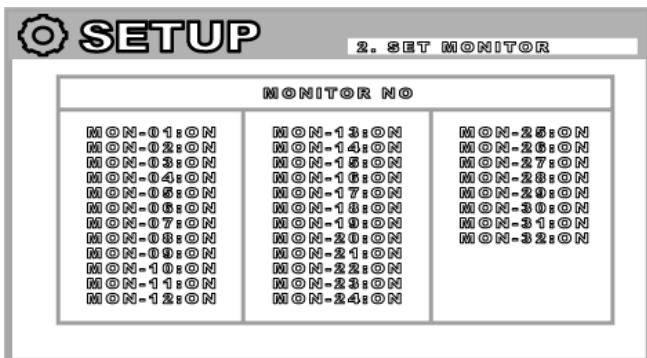

① Select "SET MONITOR" by moving Joystick up/down.

② Press  to enter Monitor Setup Mode.



- Max. 32 Monitors can be set.
- Move to "Monitor No" you like by using Joystick up/ down, left/ right.
- You can turn it on/ off by turning the upper Joystick(Head) clockwise or counter clockwise.

- on: Monitor in Use
- off: Monitor not in Use

③ After Setup, press  to escape to previous menu or press  to completely get out of the 'SETUP' mode.

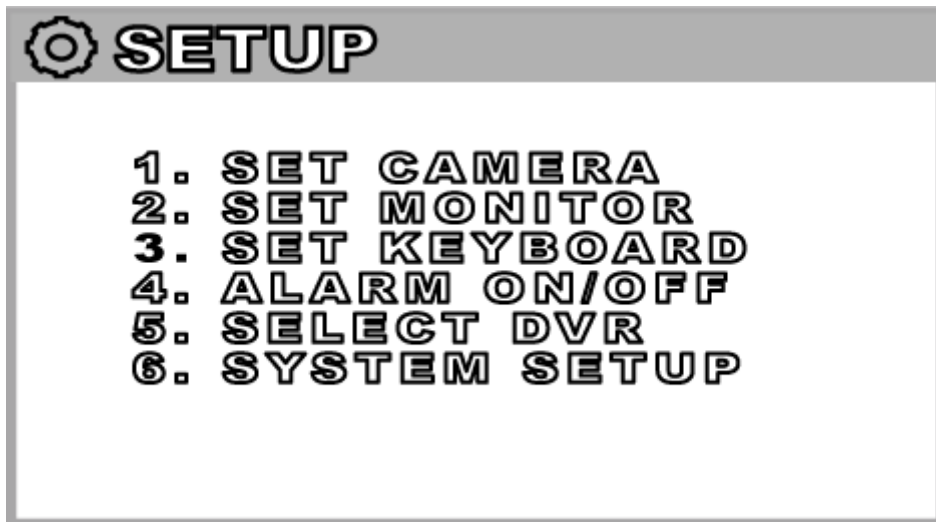

### ③ KEYBOARD SETTING

Here you can select the usage of the keyboard.

① On this main “SETUP” Menu, move to “3. SET KEYBOARD”

② Press  to enter Keyboard Setup Mode.

③ Select article number by moving Joystick up/ down and change value moving Joystick left/ right.

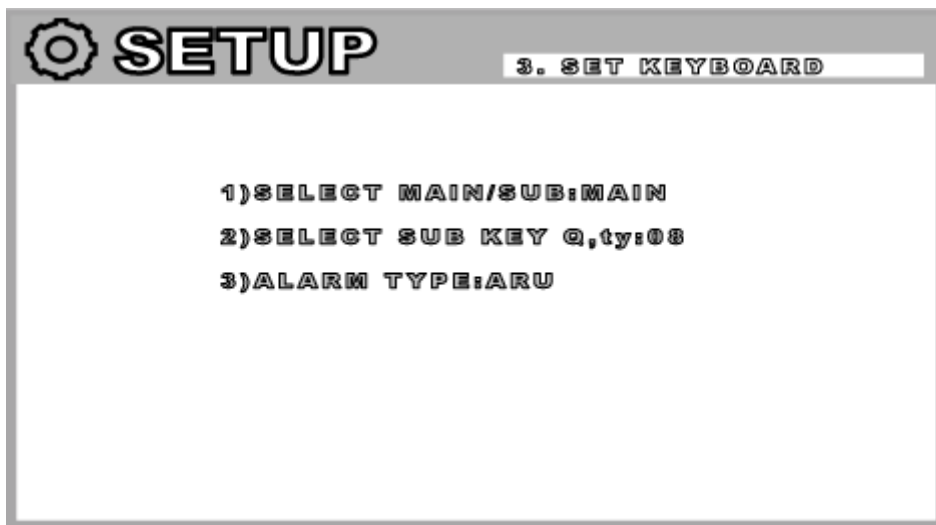

#### 1) SELECT MAIN/SUB

- The unit can be set as Main Keyboard or Sub Keyboard..
- Default is “MAIN”. Move the Joystick right to set as SUB 1 ~ SUB 8..

◆ If it is chosen as SUB Keyboard(SUB1~8), article No.2, 3 will disappear.

#### 2) SELECT SUB KEY Q'ty

- If the unit is set as “MAIN” keyboard, Quantity of Sub keyboard should be given.

- Up to 8 Sub keyboards can be set.

### 3) ALARM TYPE



- ARU(Alarm Receiver Unit): With ARU connected, Alarm signal can be received..
- CAMERA: The camera receives Alarm signal by itself.

◆ ex).

1) SELECT MAIN/SUB: MAIN -----> The user wants to use it as Main Keyboard.

2) SELECT SUB KEY Q,ty: 05 -----> It will allow max. 5 Sub keyboards.

3) ALARM TYPE: ARU -----> and Alarm signal will be received on ARU.

④ After you are done with the Keyboard Setup, escape the Menu by  or  key.'

### ④ ALARM On/Off

You can use camera alarm connected to the Keyboard..

• In case “ALARM TYPE” is set as “ARU” on the “3. SET KEYBOARD”

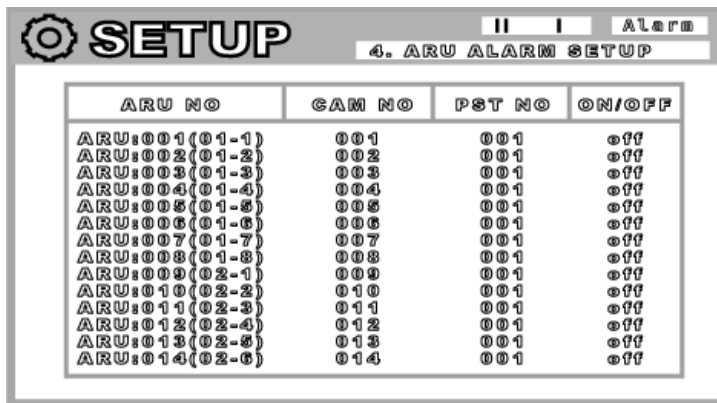

① Choose ALARM ON or OFF by moving Joystick up/ down under Main Setup Mode..

② Press  to enter “ALARM ON/ OFF” Setup Mode.



ARU NO	CAM NO	PST NO	ON/OFF
ARU:001(01-1)	001	001	off
ARU:002(01-2)	002	001	off
ARU:003(01-3)	003	001	off
ARU:004(01-4)	004	001	off
ARU:005(01-5)	005	001	off
ARU:006(01-6)	006	001	off
ARU:007(01-7)	007	001	off
ARU:008(01-8)	008	001	off
ARU:009(02-1)	009	001	off
ARU:010(02-2)	010	001	off
ARU:011(02-3)	011	001	off
ARU:012(02-4)	012	001	off
ARU:013(02-5)	013	001	off
ARU:014(02-6)	014	001	off

- Up to 504 Alarms can be set.
- Give it Camera and Preset No. and set it to 'ON' or 'OFF' by turning Joystick head.
  - on: Enable
  - off: Disable

③ After Alarm Setup is done, escape to upper menu or get out of “SETUP” mode completely by pressing  key or  key.

• In case Alarm type is set as ‘CAMERA’ on the “3. SET KEYBOARD”

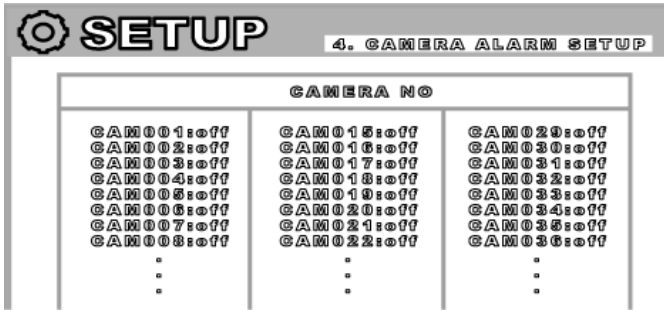

- Maximum 504 Alarms can be set.
- Move to CAMERA NO. by moving Joystick Up/ Down.
- Turning the Joystick head clockwise or counterclockwise, set it to 'ON' or 'OFF'.
  - on: Enable
  - off: Disable

## ⑤ SELECT DVR

Select compatible DVR.

- ① Choose "SELECT DVR" moving Joystick up/ down under Main Setup Mode.

- ② Press  to enter "SELECT DVR" Mode.

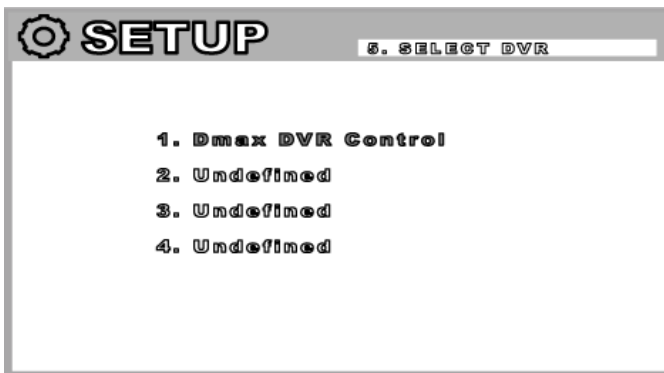

- As for now(ver.1.1), only D-max DVR can be controlled. (Other DVRs can be added later.)

## ⑥ SYSTEM SETUP

Coordinates of the Touch Pad Joystick operation can be adjusted, Password Setup and factory reset can be made under this menu.

- ① Under "Main Setup" mode, select "SYSTEM SETUP" by moving Joystick up/ down.

- ② Press  to enter SYSTEM SETUP mode.

### 1) CALIBRATION TOUCH PAD

Coordinates of Touch Pad is adjusted.



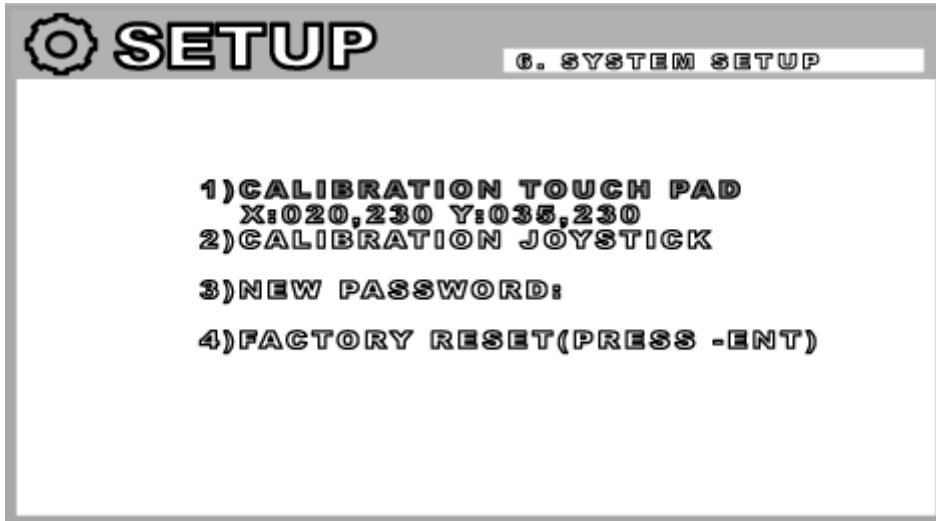

Move to “1) CALIBRATION TOUCH PAD” article and press .

Then 5 cross marks (“+”) will appear in turn. Just click on the cross using Touch pen. If the coordinates correctly pressed, you should see next coordinate. After you are done with 5 coordinates(①~⑤), “Thank you” message will show up for a few seconds and previous menu will be seen afterwards.

(If you are unable to move to next coordinate even after clicking “+”, click around “+” mark then you will be moving to next coordinates.)

①

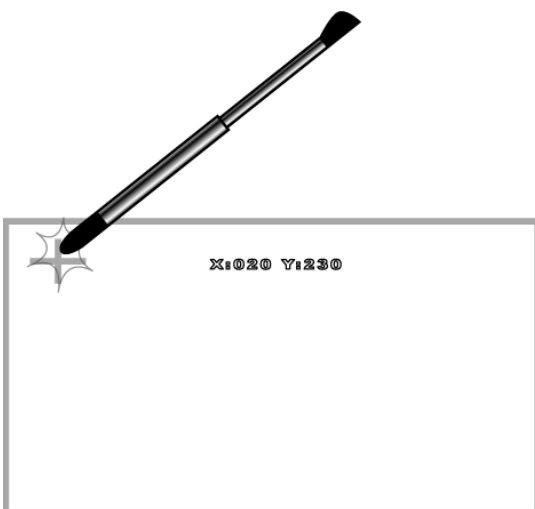

②

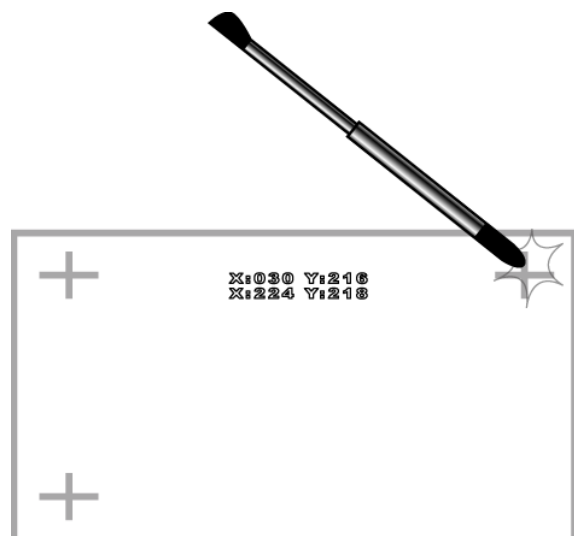

③

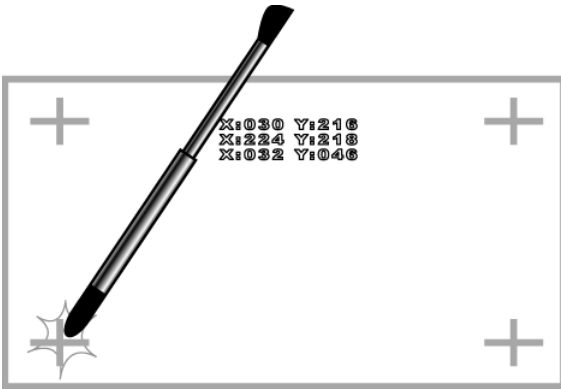

④

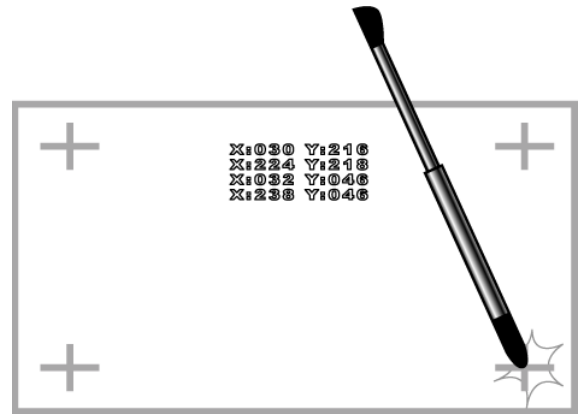

⑤

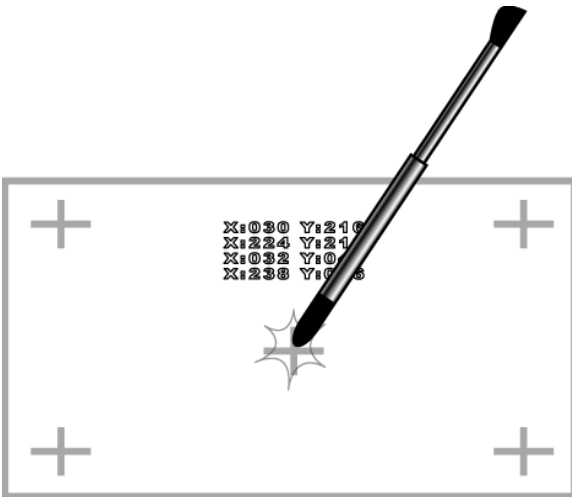

⑥



## 2) CALIBRATION JOYSTICK

Checking Out operation status of Joystick such as Zoom In/ Out, Up/ Down and Left/ Right.

① With the “2)CALIBRATION JOYSTICK” selected, press .

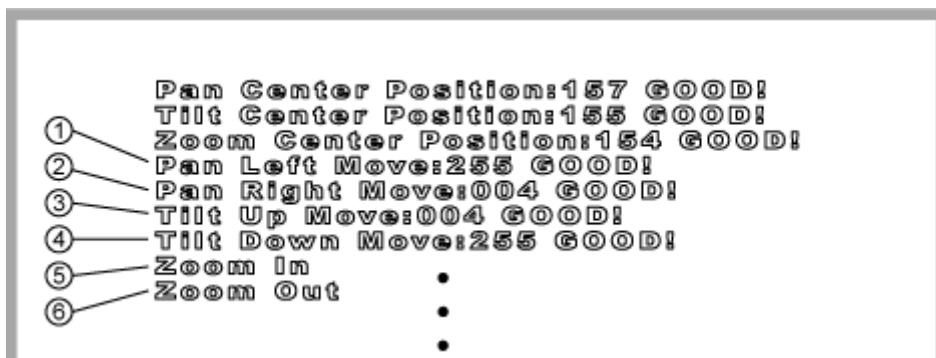

② As the following message, push the Joystick to Up/ Down, Left/ Right and turn the Joystick head clockwise or counterclockwise for Zoom In/ Out.



- ③ If all procedures are completed ok, a message, “JOYSTICK TEST GOOD!” will show up for a couple of seconds and upper menu will appear.



### 3) NEW PASSWORD

New password can be made here.

- ① With the article, “3)NEW PASSWORD” selected, input  key.
- ② Input new password and press  button
- ③ Confirm it by inputting once again. If everything is completely done. A message, “THANK YOU” will appear.

### 4) FACTORY RESET

All Setup value will be changed into “DEFAULT”..

- ① Press  with the “4)FACTORY RESET” selected.
- ② Press  button once again to confirm the “FACTORY RESET” and “PLEASE WAIT” message will appear. If you change your mind to cancel the “FACTORY RESET”, please push the Joystick into Up or Down.

### 3). CONTROL MODE Setup

You will come to know more details about PTZ, MATRIX, DVR mode on this chapter.

#### Basic Operation Interface

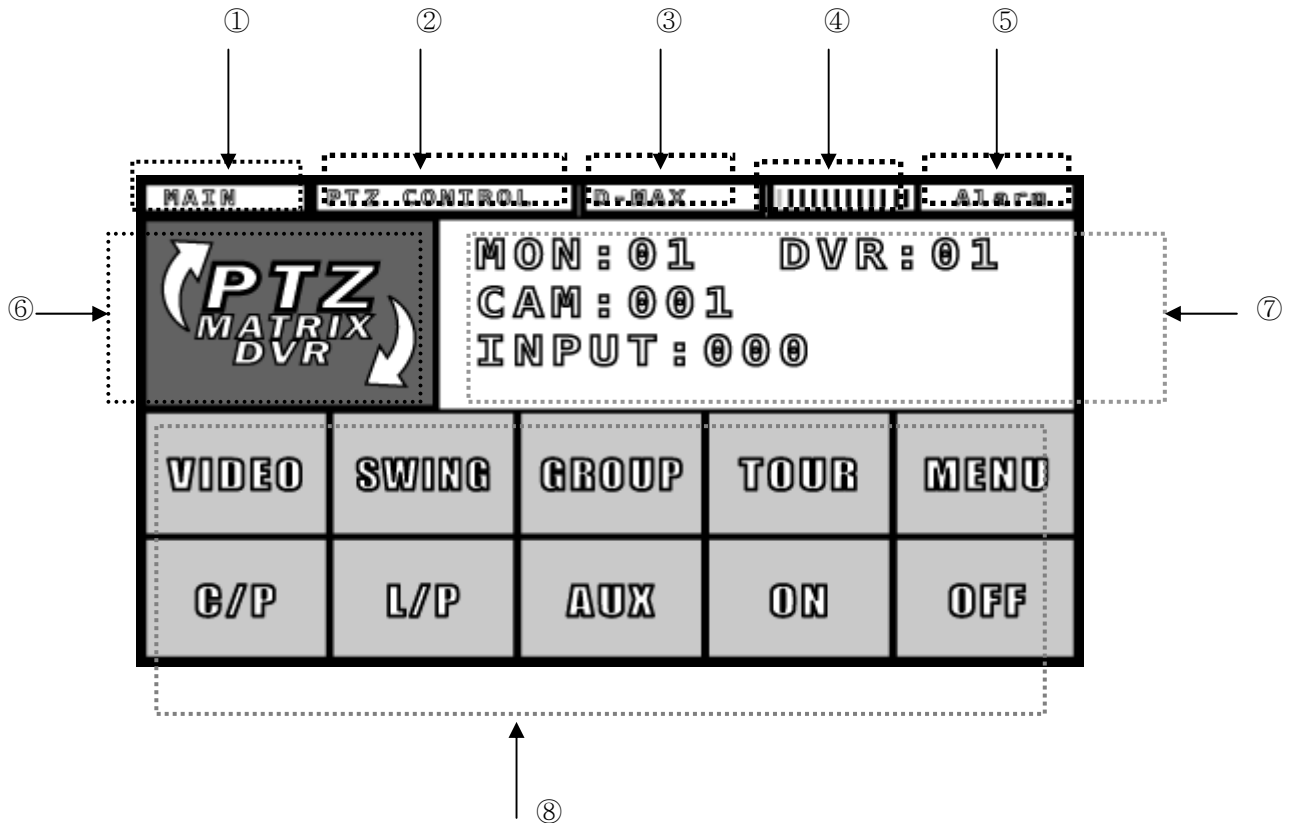

① MAIN/SUB Keyboard Indicator

- It indicates on PTZ/ MATRIX mode if the unit is main keyboard or sub keyboard. (It also shows if the unit is 1<sup>st</sup>, 2<sup>nd</sup> or 8<sup>th</sup> keyboard.
- Please refer to “2. SETTING the SETUP Mode” for main/ sub keyboard setup.

② Indicator for Mode status

- It indicates if the current status is in PTZ, MATRIX or DVR mode.

③ Protocol Indicator

- The current protocol set is indicated.

④ Indicator of communication status

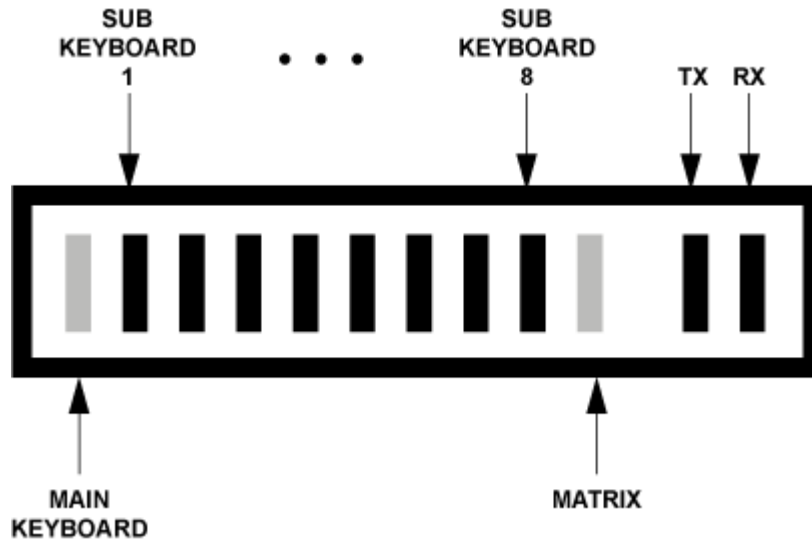

– This section indicates connection status of MAIN/SUB KEYBOARD and signals of MATRIX, TX, RX.

- MAIN KEYBOARD: If the unit is set as main keyboard, it blinks.
- MAIN/SUB KEYBOARD 1~8: If you have set SBU KEYBOARD, it will be seen in red.

(The first bar would blink when the unit is set as MAIN Keyboard.)

- MATRIX: If the unit is connected with MATRIX, it flickers.
- TX/ RX: They blink when there are TX/ RX signal.

⑤ It indicates Active or Inert status of ALARM. Press  button after ALARM is turned on and it will turn into RED and Alarm will be activated.

⑥ Button for CONTROL MODE conversion

– Whenever this button is pressed, it will be converted from PTZ ► MATRIX ► PTZ in rotation.

– Press  button to enter DVR mode.



⑦ Input value of Monitor, Camera, DVR and other commands will appear in letters.

⑧ Each CONTROL MODE is shown.

# 1. PTZ CONTROL MODE Setup and Functions

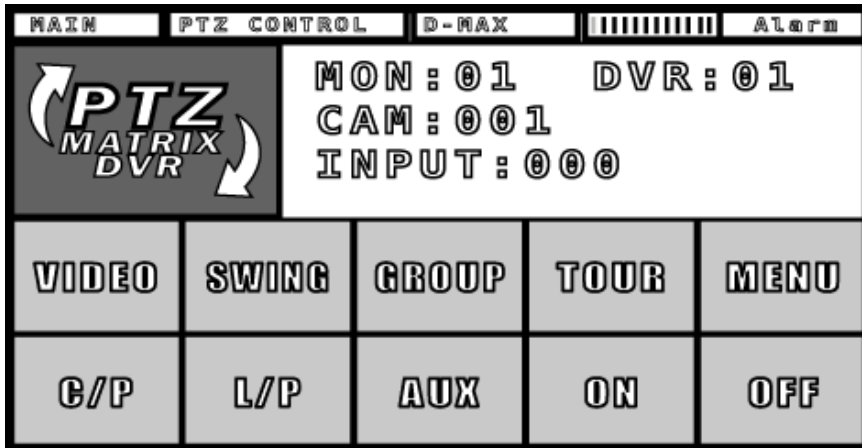

## ① Setting PRESET

This function allows the camera to automatically move to the designated positions and the keyboard can program up to 500 preset positions for each camera. The memorized preset position can be replaced with new preset position (new value).

### ① Setting PRESET

By using Joystick, move the camera to which you like to set and press



### ③ Calling Preset Positions you previously set



### ④ Individual deletion of PRESET

If you hold the **CLR** button for 3 seconds, a message, 'Clear Function!' will appear and it will become CLEAR Mode. Delete Presets you want and get out of the 'CLR' Mode by pressing **CLR** button again.

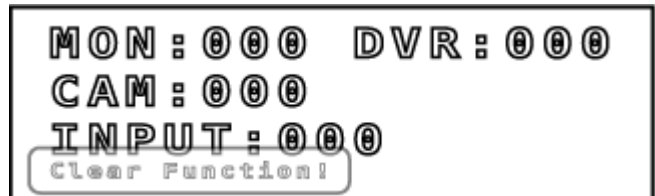

Press **CLR** button for 3 seconds until you hear a beep and press 1 ~ 2 5 0 → P-SET

### ⑤ Deleting All Presets

Hold the **CLR** button for 3 seconds and you hear a beep. Then press P-SET → ENT

※ Maximum quantity of PRESET positions input may be subject to the features of camera or receiver.

## ② Setting SWING

You may select only 2 preset positions memorized from what you had set at preset mode (in horizontal or vertical) and exercise surveillance repeatedly over the memorized areas. The keyboard can program either Pan Swing or Tilt Swing

① Set Swing mode

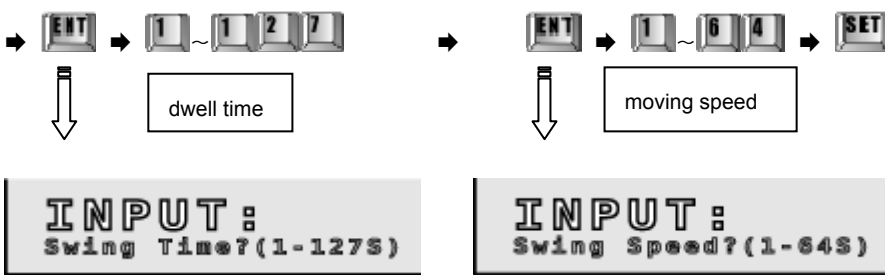
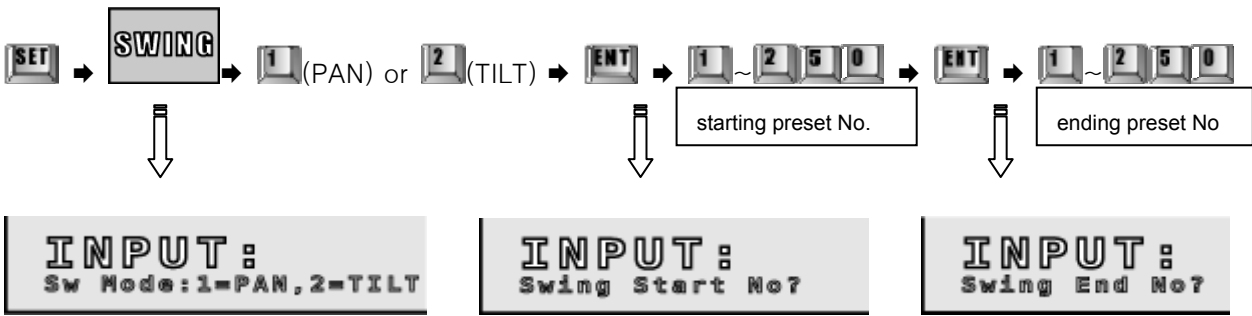

- ※ Pressing **SET** button, 'Camera Set Function' in red will appear at the bottom and it means "SET" mode. (Push **CLR** key if you want to cancel SET mode)
- ※ Swing Time is DWELL TIME that the camera stays before camera moves from a starting position to ending position and it can be set from 1~127 seconds.
- ※ Moving speed is that the camera moves from starting point to ending point. Maximum speed is 64..
- ※ Set PAN SWING to No.1, TILT SWING to No.2. Please be sure to place them in straight line in order to protect malfunction. (Pan in horizontal line, Tilt in perpendicular.)

② Swing 실행



③ Stopping Swing

Just press **SWING** button or touch the Joystick  to stop it. (It will go back to operation after few seconds.)

- ※ When it is being used as 'Auto Pan' of CCTV Receiver, you are required to push 'SWING' key and you can't stop it with Joystick.

③ GROUP 설정

Maximum 12 Preset Points can be set in one GROUP. You can make up to 12 GROUPs setting speed, dwell time.

① Inputting GROUP

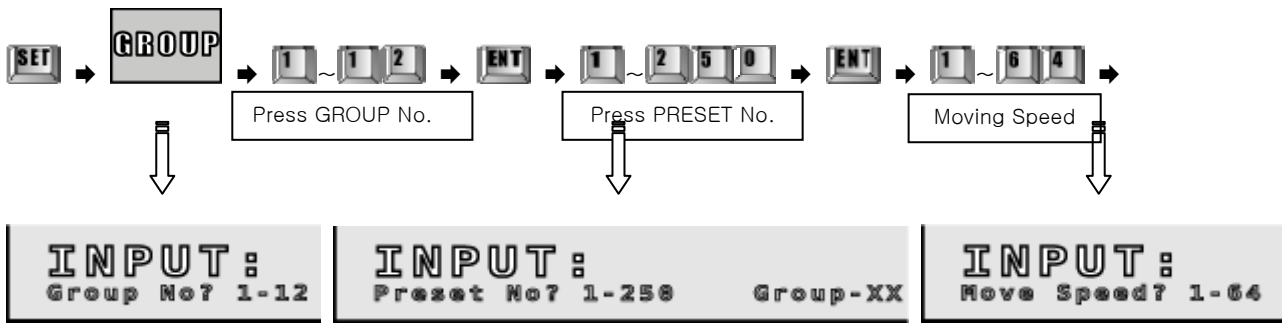

Dwell Time: The time that the camera stays from preset point to the next point.



※ In order to finish one GROUP and set other GROUPs, press **SET** key after you finish procedures of inputting PRESETs.

※ After you finish all inputting procedures, press **SET** key and enter Normal Mode.

② Executing GROUP



③ Stopping GROUP

Press **GROUP** button or touch the Joystick  to stop. (If you stop it by Joystick, It will be running again.)

④ Deleting GROUP



※ Press **CLR** key until you hear a beep and put your hand off from the button.



There is no way to delete each GROUP respectively and all GROUPs will be deleted at a time.

#### ④ Setting TOUR

Up to 12 GROUPs can be tied in TOUR and it enables you to execute those GROUPs consecutively.

##### ① Inputting TOUR

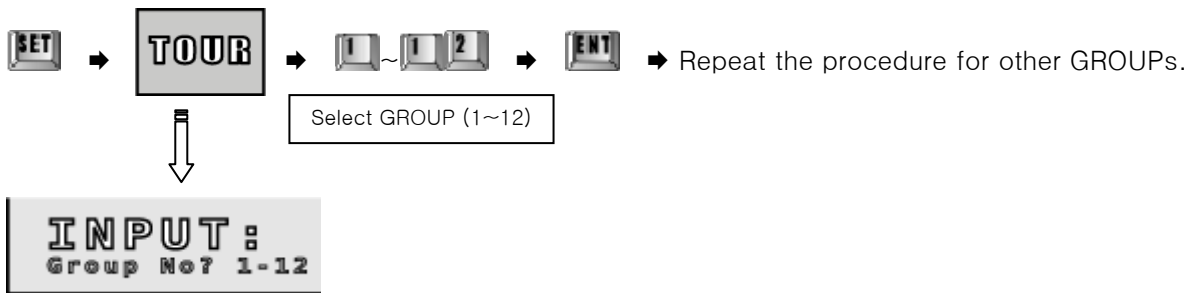

→ When you finish all inputting, press SET key at the last.

##### ② Execute or Stop TOUR

Touch TOUR key to execute and touch TOUR again or  to stop.

If it is stopped by Joystick, TOUR function will resume in a few seconds.

##### ③ Deleting TOUR

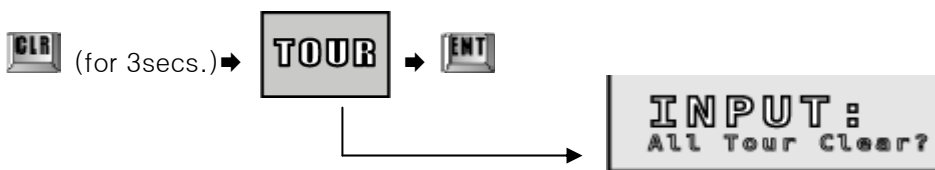

※ Hold the CLR button until you hear a beep.

※ If the TOUR is deleted, the GROUP tied in it will also be deleted.



⑤ If you touch VIDEO button when the video line is input, it will be converted to Full screen Display Mode.

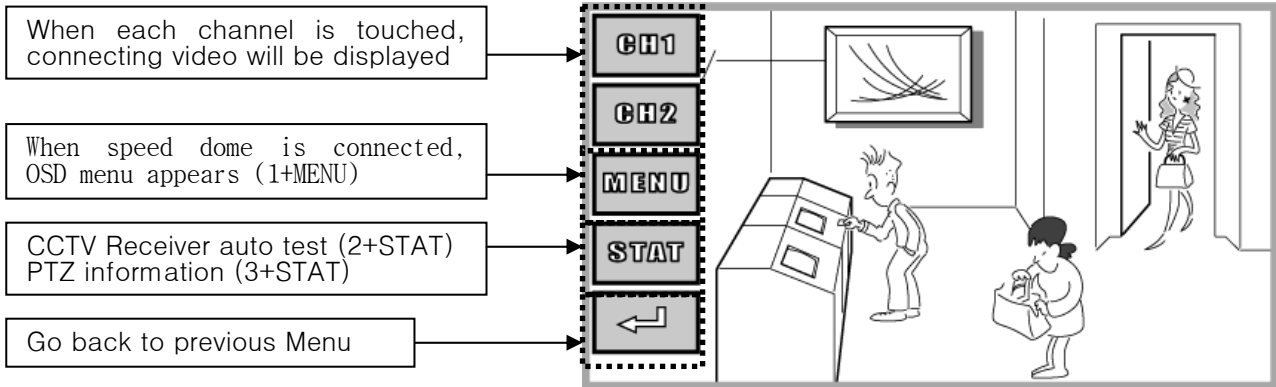

⑥ Set TRACE

This function allows you to track (play back) the movement the user had operated with panning, tilting, zooming for more than 95 seconds.

① Set TRACE

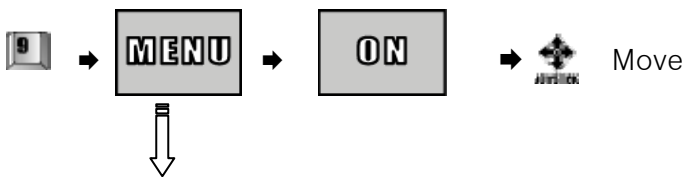

※ If Trace has already been set, 'Sorry Not Blank!' will appear and you will need to set up again after deleting Trace.



※ While you move the Joystick it saves and its progress will be seen as left drawing.

←Video from Monitor

② Run TRACE

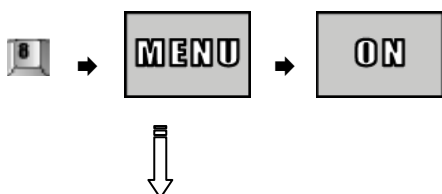



③ Stop TRACE

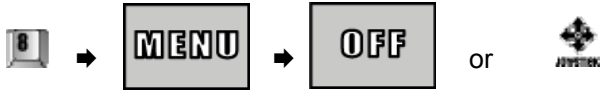

④ Clear memorized TRACE



\* Please study camera manual for more details about Trace function.

⑦ Turning ON/OFF the Camera, Light Power

Select a receiver (camera) you wish to ON/OFF [1] ~ [5] [1] [2] → [CAM]

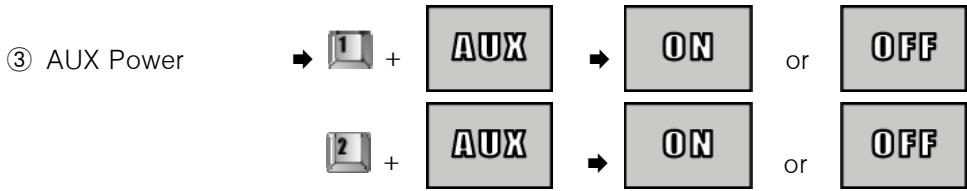

※ This function is only subject to CCTV Receiver.

## 2. Setup for MATRIX CONTROL Mode

### ① Enter MATRIX CONTROL

Touch conversion button for CONTROL MODE to change it into MATRIX CONTROL MODE.

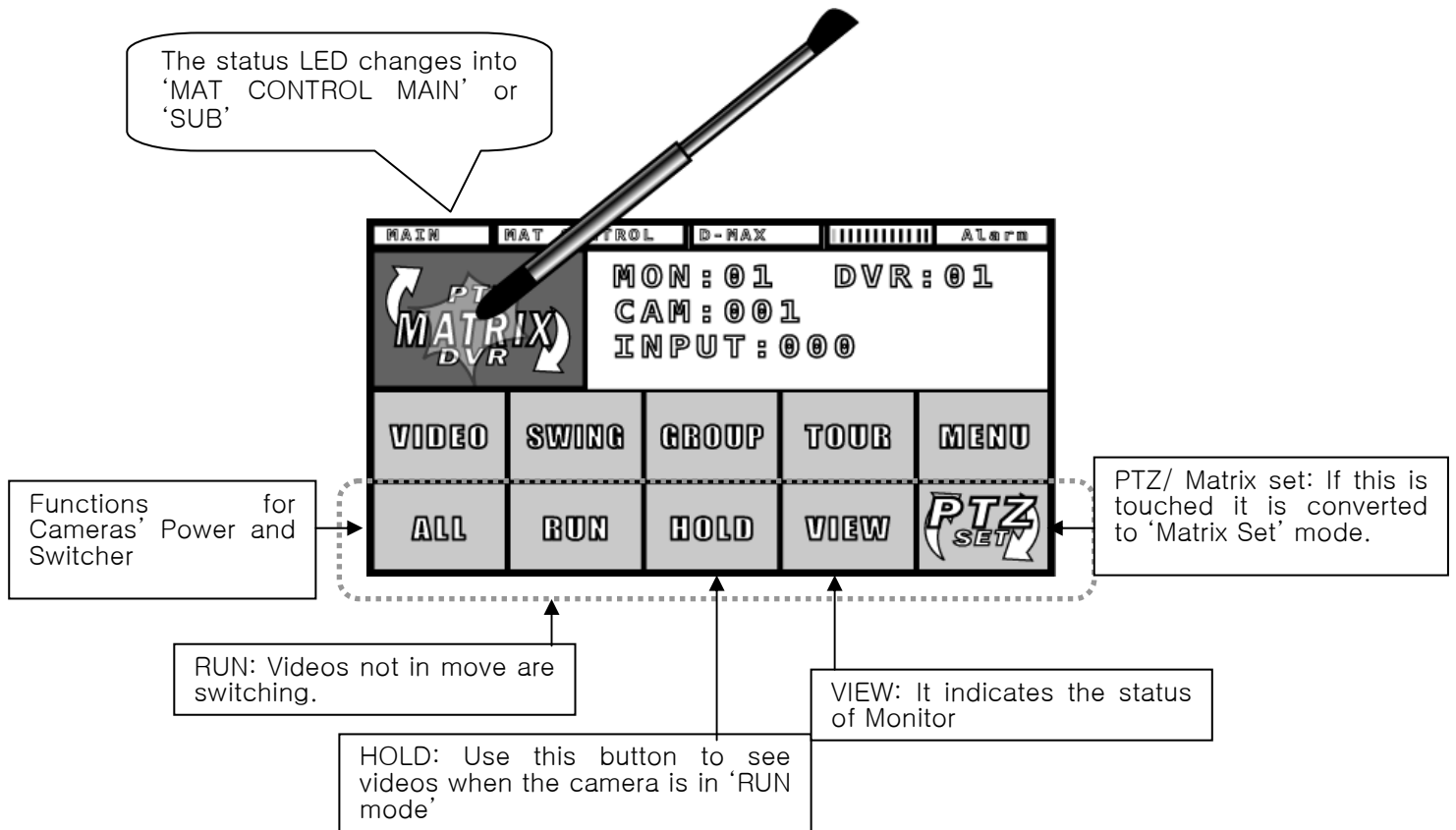



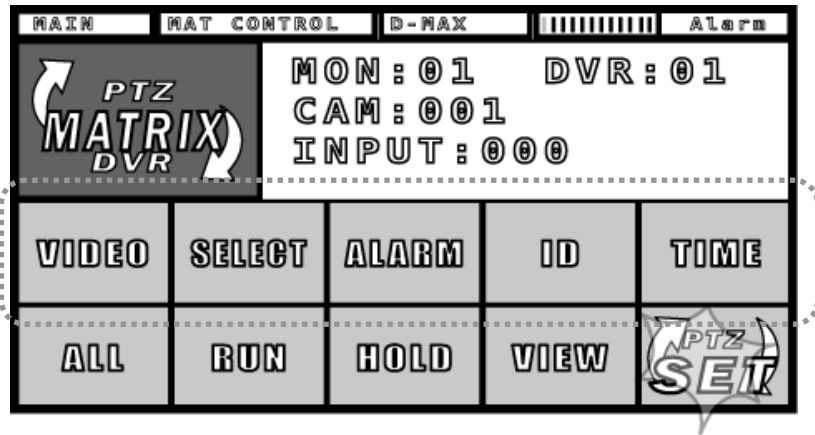

Like above picture, all those buttons at bottom will be changed into Matrix Control Buttons at 'Matrix Control Mode.'

(\* Please study MATRIX instruction manual for more detailed use of Matrix.)

### ② MATRIX SET mode



If PTZ/ Matrix SET button at the right bottom is touched, a window will be created asking for Password. If correct password is input, the menu will be converted as above.

- ①  : Entering 'AUTO SELECT SET'
- ②  : Entering 'ALARM/PRESET SET'
- ③  : Entering 'ID SET'
- ④  : Entering 'TIME/DATE SET'

(\*Please consult Matrix Instruction Manual for detailed setup of Matrix.)

If you touch 'PTZ/ Matrix SET' button one more time after you finish Matrix Setup, OSD Menu will disappear and you should go back to Matrix PTZ mode.

NOTE: Press below buttons when MATRIX OSD is not shown.





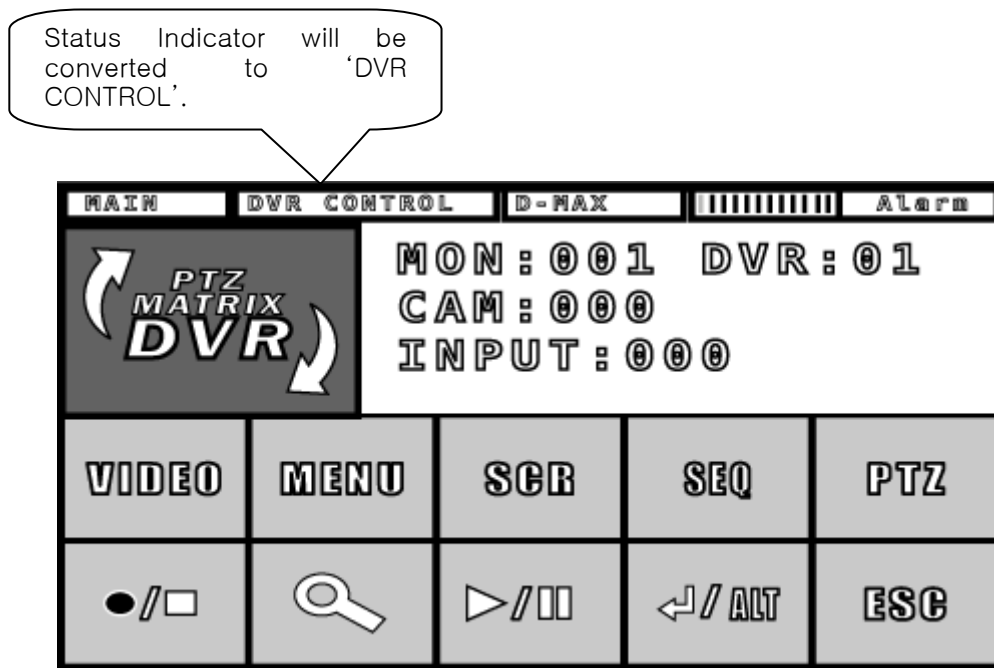

### 3. Setup for DVR CONTROL Mode

#### ① Setup to enter DVR mode

Press  button at the keyboard and you will be in DVR CONTROL MODE..

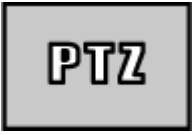

-  ⇒ Enter DVR OSD MENU
-  ⇒ Video will be changed into 4/ 9/ 16CH
-  ⇒ Video automatically switches or stops
-  ⇒ To enter PTZ mode
-  ⇒ Starts/ Stop Recording

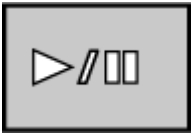

⇒ Playback/ Pause at Playback mode



⇒ This button is used as a function key in 'Live view' and 'Enter' in other menus or search mode



⇒ Move to upper menu or cancel the command

ex). In case you like to see full view of CH No.14 from DVR No 3(16CH) and change it into 16CH view. (At first, On 'Set Camera' from SETUP mode, please make the CH No. as Camera No. and set it to 'DVR mode'.

CAMERA NO	SELECT	PROTOCOL	SPEED
CAMERA:001	DVR Mode	D-max	9600
CAMERA:002	DVR Mode	D-max	9600
CAMERA:003	DVR Mode	D-max	9600
CAMERA:004	DVR Mode	D-max	9600
CAMERA:005	DVR Mode	D-max	9600
CAMERA:006	DVR Mode	D-max	9600
CAMERA:007	DVR Mode	D-max	9600
CAMERA:008	DVR Mode	D-max	9600
CAMERA:009	DVR Mode	D-max	9600

+ , + → CH No.14 of DVR No.3 will show you the video in Full.



Touching button you will see the monitor changing to 4CH, 9CH, 16CH in rotation

※ Please consult the DVR instruction manual for DVR OSD Menu or other related information in detail..

## 4) Other Detailed Functions

### ■ Select Camera



! Press any camera number (1~255) you wish to control  
and  key

### ■ Select Monitor



! Press any monitor number (1~32) you wish to control  
and  key

### ■ Select DVR



! Press any DVR number (1~64) you wish to control  
and  key

## 5). OSD Setup Mode

### 1. Entering OSD Menu

It brings in camera own menu and the menu will appear with beep sound on monitor if you input as below



### 2. Control OSD Menu

The cursor will be flickering on monitor (waiting for command)

Move the Joystick right/ left, up/ down and put the cursor as desired.

### 3. Getting out of OSD Menu



Do as above and the menu on the monitor will disappear and the OSD menu will be released..

※ This function can be used in the speed dome camera only.

※ Please refer to the camera instruction manual for more detailed usage of OSD menu.



## 6). Other Setup Mode

### ① Spiral Function

This function is supported only on speed dome cameras, the fixed panning speed and tilting speed are operated at the same time that can make spiral surveillance

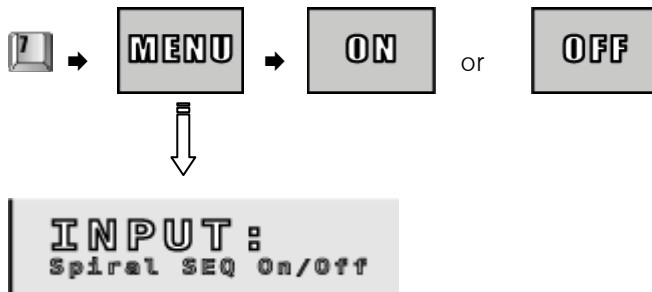

※ This function can be used in the speed dome camera only.

### ② Camera Remote Reset

Initialize the camera or receiver in case they have a problem.

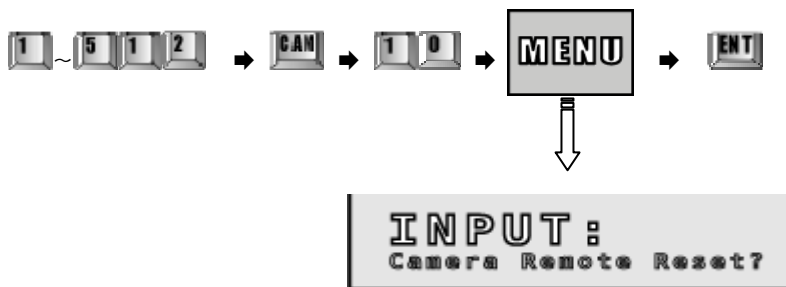

※ This function can be used in the speed dome camera only.

### ③ Keyboard Buzzer On/Off

Turn on/ off the buzzer of the keyboard.



### ④ LCD Contrast setting

You can adjust Contrast of the LCD when it's in 'VIDEO' mode.

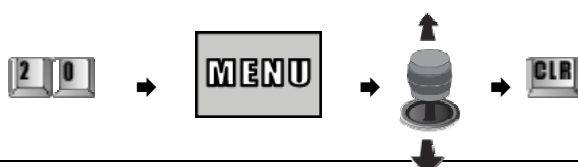

⑤ Converting Up/Down

Convert the control of up/ down, for instance, If you move the joystick down, it will go up.



⑥ Converting Left/ Right

Convert the control left/ right, for instance, if you move the joystick left, it will move right



2) ⑦ Convert the voltage of Lens Control

When the movement of Zoom Lens is too slow or fast, you can change the voltage to adjust the proper speed



⑧ Power all On/Off

Power of all cameras can be turned on or off at a time.

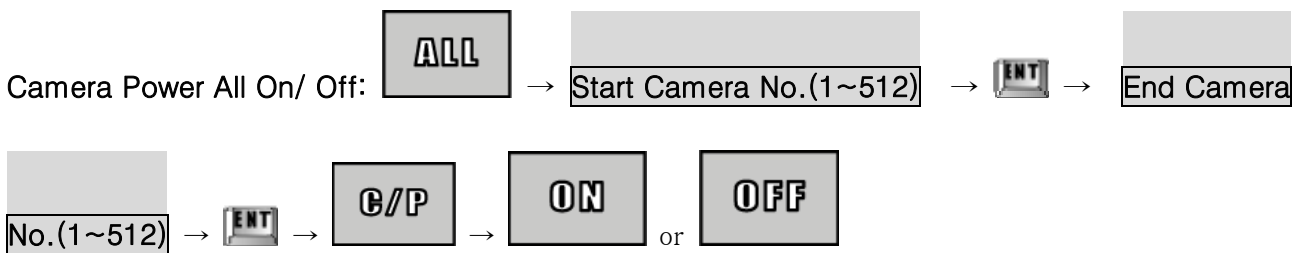

※ Article ⑤~⑧ are for DRX-500, DRX-502A and SRX-100B(CCTV Receivers).

⑨ Alarm Relay On/Off

Alarm Relay inside Speed Dome can be turned On/ Off.

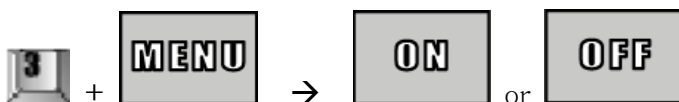

• 'Relay On' or 'Relay Off' will be shown on the screen.

⑩ Camera Sensor

It allows the Speed dome to move to designated Preset position with Speed domes's sensor. Preset number for each sensor can be set here.

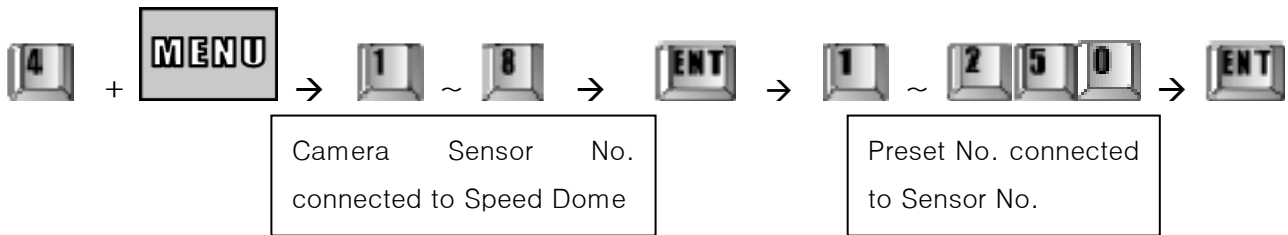

⑪ Control Joystick Speed (Joystick Speed (0,1) 0=MAX)

After decreasing its speed you may control the dome more precisely.



- 0: Default, 1: Cut down Speed

⑫ Auto RTS On/Off

When several keyboards are connected, you should decide if you set all of them to 'Main' in parallel connection or set Main or Sub separately.

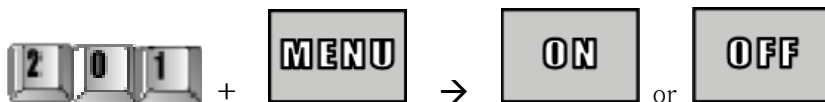

On: Sub Data is come through the Main Keyboard and it is working reliably.(Default)

Off: All Data goes through Main so it can cause a malfunction.

⑬ Setup for PTZ Camera Fan (Dome FAN AUTO?)

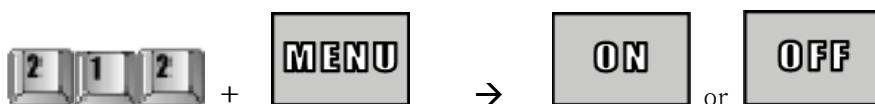

On: Fan inside the PTZ Camera can be automatically operated.

Off: Fan inside the PTZ Camera can be manually operated.

⑭ Fan On/Off of PTZ Camera (Dome FAN ON/OFF?)

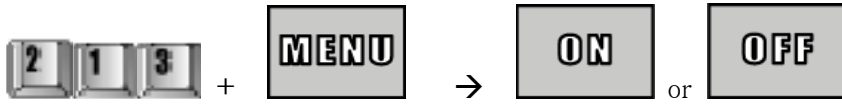

On: Fan inside PTZ Camera is turned on.

Off: Fan inside PTZ Camera is turned off.

## 4. More Cautions and Check Points

### Cautions in Use

- Do not give a power to the unit in the process of installing.
- It is recommended that the unit be installed in a well-ventilated place since the operating range is 5°C~40°C.
- Do not expose the unit to extreme impact, which may cause serious damage.
- Avoid installing in the direct rays of the sun.
- Never install the unit in place with strong magnetic, an electric or a radio wave which cause a problem in communication.
- Be careful not to connect wrong cable or line while installing.
- Never operate the unit until the buzz(beep sound) goes off after turning on the power.
- Give a power to the unit after you check the insulated wire connected outside.
- Always use the keyboard cable provided with the keyboard.
- Do not give too much strength to the joystick while controlling.

## Simple Trouble Shooting

Please check out followings when you face some problems while installing or using.

Problem	Check Point	Reference
The power can't be brought.	Is the connection between keyboard and junction box correct?	Make sure to connect the Modular cable. (RJ45)
	Is the Power sources being supplied now?	Be sure to plug the power supply into the consent.
The camera can't pan/ tilt.	Did you press the camera number correctly?	Try again after pressing CLR button.
	Is the RX address the same as Camera address?	Check out again the DIP Switch of the RX.
It's not working in Sub-keyboard.	Hasn't the sub-keyboard address been repeated as you initially set?	Check setup of main/ sub-keyboard again.
	Has the data cable been connected correctly?	Check the connection and polarity of the data cable.
Preset movement is not working.	Have you set Preset positions at Preset mode?	Set Preset position and try again.
	Does the camera support Preset function?	Press number 3 and STATUS key and check out the camera model.
There is an error when setting motion.	Have you set it on Main keyboard?	It can't be set on Sub-keyboard.
Alarm can't be on..	Have you set off the all Alarm channels?	If you set it off it can't be on. Please refer to the Alarm setup page.

# 5. Dimensions

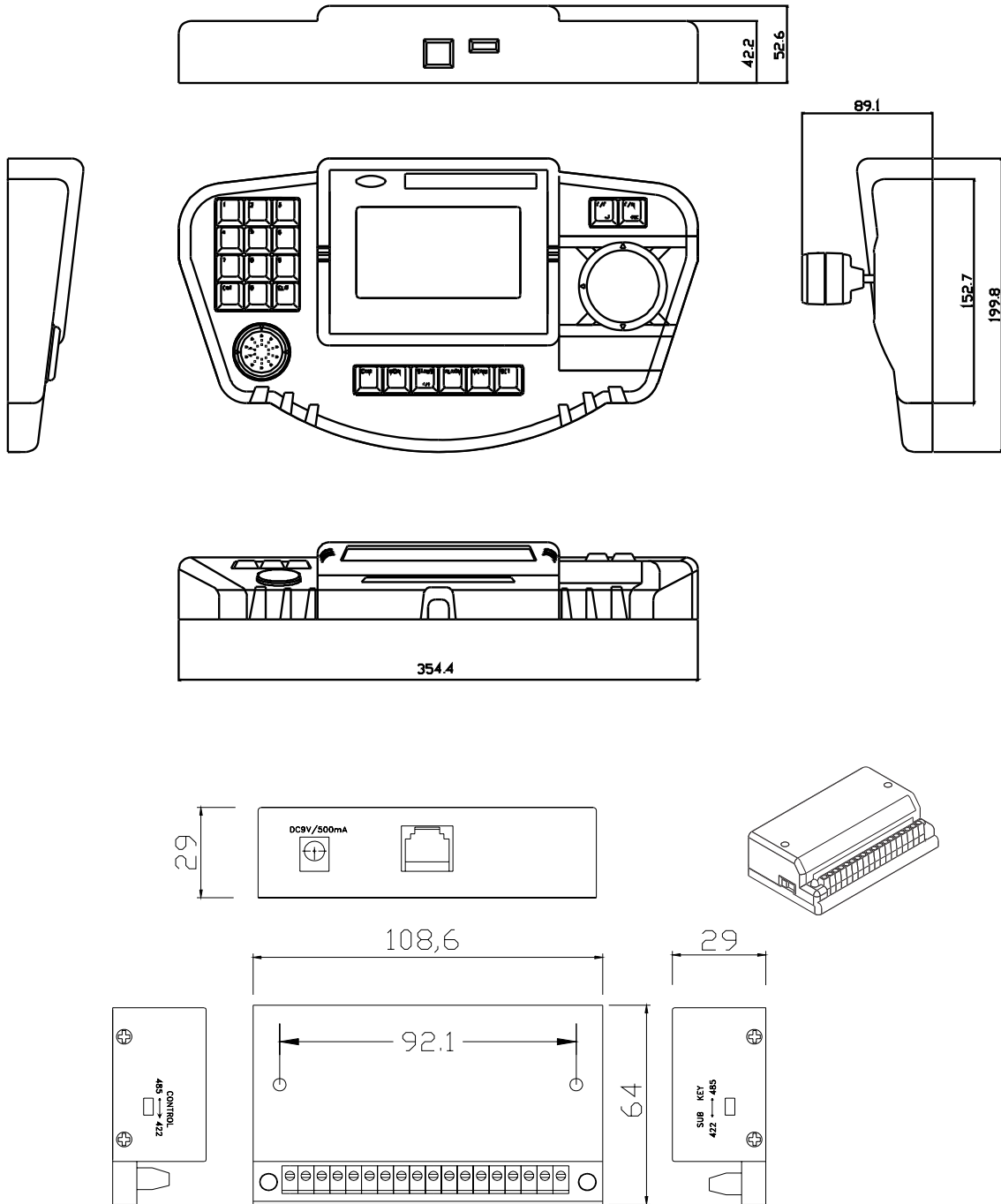

JUNCTION BOX

## 6. SYSTEM Configuration

1. When the keyboard is directly connected to PTZ Camera.

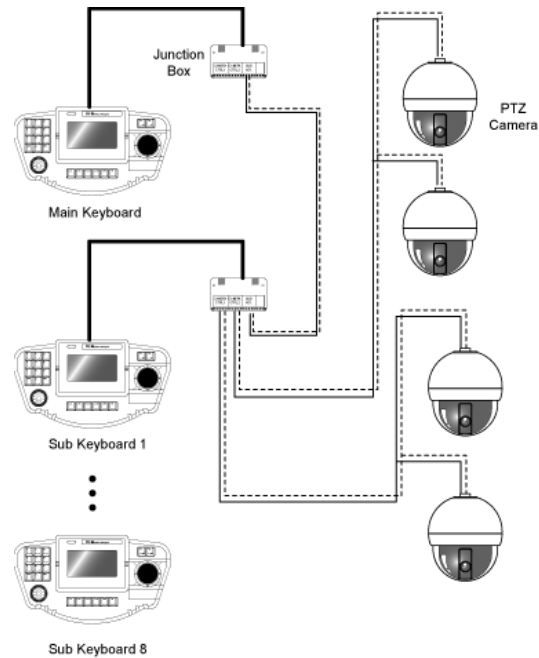

2. When connected with Matrix System (DMX-25632) and PTZ Camera

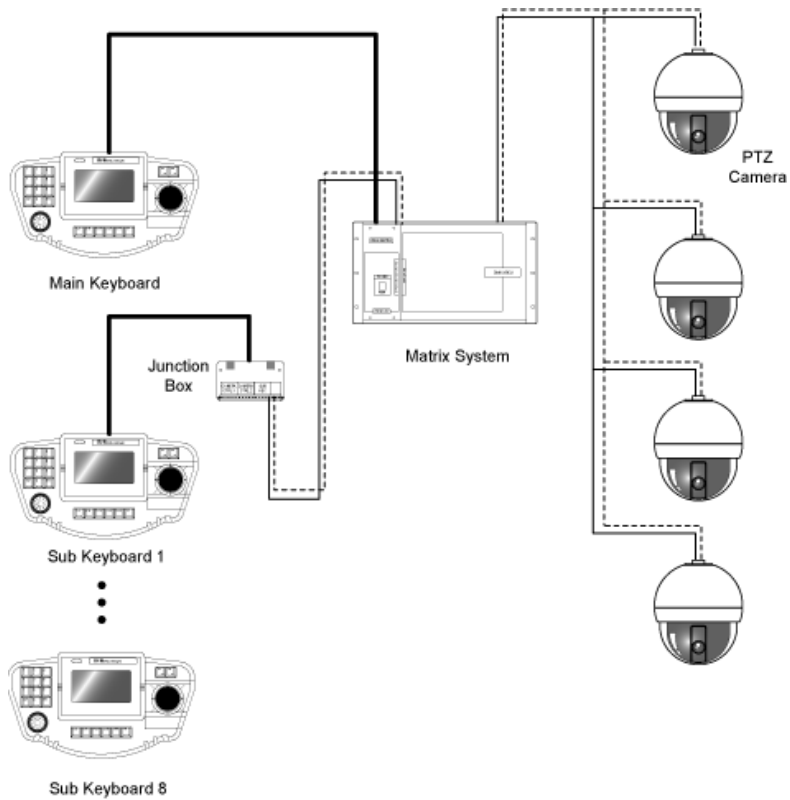



3. When connected with DVR- Matrix System(DMX-25632) and PTZ Camera.

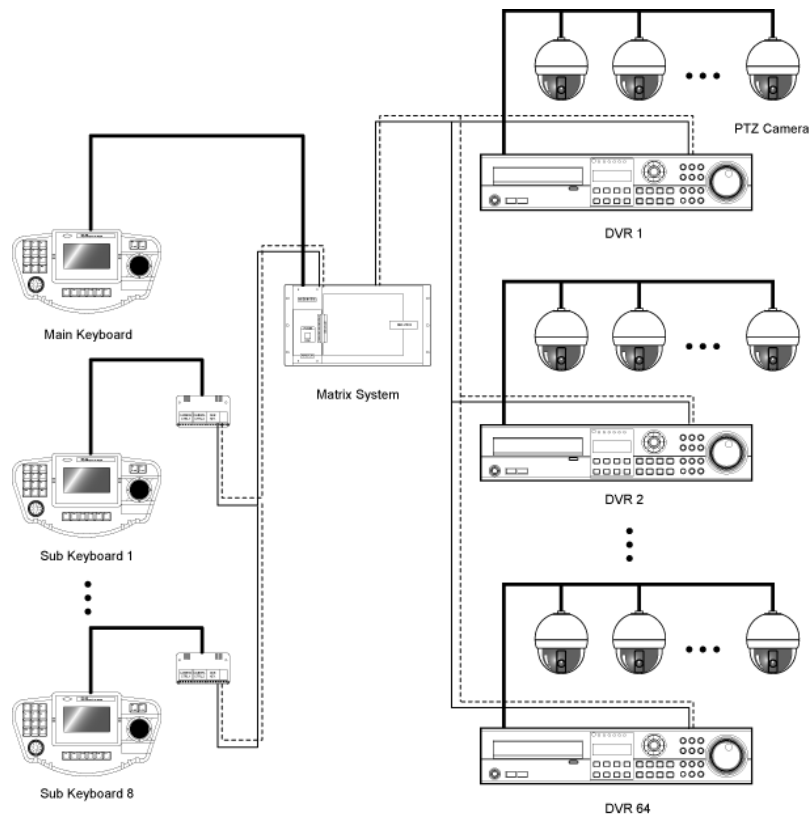

## 7. General Specifications

### 1). Product Standard

Classification	Specification
Output Signal	<ul style="list-style-type: none"> <li>● RS – 422</li> <li>● RS – 485</li> </ul>
Communication speed	<ul style="list-style-type: none"> <li>● Speed 9,600, 4,800, 2,400BPS, No parity, 8Bit data, 1Bit stop</li> </ul>
Operation	<ul style="list-style-type: none"> <li>● Control Pan/Tilt /Zoom lens</li> <li>● Camera power On/Off , Light power On/Off , AUX On/Off</li> <li>● Alarm On/Off , Preset set/clear ,OSD</li> <li>● Control Matrix</li> <li>● Main / Sub keyboard</li> </ul>
Operating Status (Display)	<ul style="list-style-type: none"> <li>● Display : LCD Display ( The way to select Menu )</li> <li>● Input ? : Number input by Key can be outputted.</li> <li>● Camera : If camera is called input data can be outputted.(1~256)</li> <li>● Monitor : If monitor is called input data can be outputted1-64)</li> </ul>
Sound in Use	<ul style="list-style-type: none"> <li>● When pressing key : Make a buzz sound for about 0.5seconds.</li> <li>● When inputting wrong data : Make a buzz sound for 3 times.</li> <li>● If alarm is sounded when Alarm is on : it keeps making a warning beep sound To release the Alarm, press “CLR” key.</li> </ul>
Accessories	<ul style="list-style-type: none"> <li>● Body of keyboard -1-</li> <li>● Modular cable(RJ-45cable with 10M long) -1-</li> <li>● Data junction box -1-</li> <li>● DC 12V 1.5A Adaptor -1-</li> </ul>

### 2). Controller Specification

ITEM	Specification
In/ Output Terminal	Modular jack
Communicate with Junction Box	TTL
Operating Temperature	0 ~ 40。 C
Storage Temperature	-5 ~ 55°C
Operating Humidity	10 ~ 75%
Storage Humidity	10 ~ 95%
Dimension	338(L)×180(W)×45(H)
Weight	Approx. 1.2kg

### 3).Junction Box Specification

Item	Specification
In/output terminal	Modular jack
Power supply	DC 12V, 1A Adapter
Camera Control	RS-485/RS-422
Operating temp.	0 ~ 40。 C
Storage temp.	-5 ~ 55°C
Operating humid.	10 ~ 75%
Storage humidity	10 ~ 95%
Dimension	109(L)×66(W)×27(H)
Weight	Approx. 0.3kg

#### 4). Power Supply

Voltage : DC 12V ( $\pm 10\%$ )

Current : 1.5A (min)

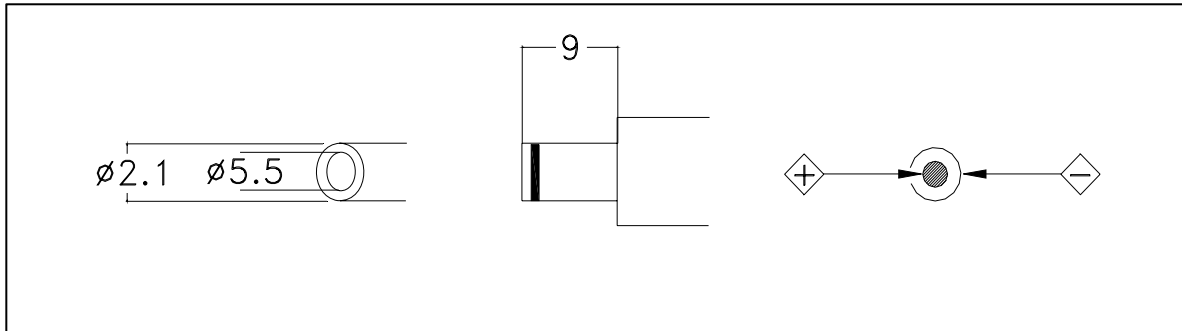

#### 5). CAMERA CONTROL INTERFACE

ITEM	Specification
Synchronization / System & word length	Asynchronous Serial Interface
	1 Start bit
	8 Data bit
	No parity
	1 Stop bit
	11 Byte command
Signal polarity	Mark logic "1"
	Space logic "0"
Transmit direction	Half duplex
Transmit speed	9600 bps

#### 6). Constitution of pin between controller and junction box (Modular Jack)

Pin no.	Controller ↔ Junction box
1	RX-TXD
2	B+12V
3	RX-RXD
4	RX-RTS
5	GND
6	SK-TXD
7	SK-RTS
8	SK-RXD

## 8. Quick Reference

Operation	Function	Function Input	
		Main	Sub
Keyboard [1-64] + [MON]	Select Monitor	⊙	⊙
Keyboard [1-512] + [CAM]	Select Camera	⊙	⊙
Power supply ON + [SET]	Setting Controller	⊙	⊙
[SET] [SET]+[Joystick Stop]+[Keypad 1~128]+[PST] [Preset No]+[PST] [CLR+3sec]+[Keypad 1~128]+[PST]+[ENT] [CLR+3sec]+[PST]+[ENT]	Start Setup mode for Preset Run Preset, Preset movement Deleting each Preset Clear all Preset Positions	⊙	⊙
[SET]+[SWING] [1/2]+[ENT] [Keypad1~128]+[ENT]+[Keypad 1~128]+ [ENT] [Keypad 1~127]+[ENT] [Keypad 1~64]+[ENT] [1/2]+[SWING]	Start Setup mode for Swing Select Pan or tilt swing Select 2 different preset positions Set Swing Speed Set dwell time Run Pan or tilt swing Stop Swing	⊙	⊙
[SET]+[GROUP] [Keypad 1~6]+[ENT] [Keypad 1~64]+[ENT] [Keypad 1~64]+[ENT] [Keypad 1~127]+[ENT] [SET] [Keypad 1~12]+[GROUP] [GROUP]/Joystick	Start setup mode for Group Select Group number Select Preset point Set moving speed between Preset positions Set Dwell time Confirm Input value Run Group Surveillance Stop Group Surveillance	⊙	⊙
[SET]+[TOUR] [Keypad 1~12]+[ENT]←repeat [SET] [TOUR]	Start setup mode fro Tour Set Tour repeatedly End setup for Tour Run Tour Sequent surveillance	⊙	⊙
[C/P] + [ON/OFF]	Turn on/ off CCTV CAMERA power	⊙	⊙
[L/P] + [ON/OFF]	Turn on/ off CCTV LIGHT power	⊙	⊙

[7]+[MENU]+[ON] [7]+[MENU]+[OFF]	Run Spiral function Stop Spiral function	⊙	
[Keypad] [1~512]+[CAM]+[10]+[MENU]+[ENT]	Camera Reboot	⊙	
[20]+[MENU] Joystick up/down +[CLR]	Brightness Mode of LCD Ending brightness control	⊙	⊙
[11] + [MENU] + [ENT]	Converting Up / Down Mode	⊙	
[12] + [MENU] + [ENT]	Converting Left / Right Mode	⊙	
[15] + [MENU] + [1/2/3] + [ENT]	Converting Lens Voltage, 6V / 9V / 12V	⊙	
Hold down [CLR] key for 3 seconds [PRESET Number 1~64] + [PST] [PST] + [ENT] [GROUP] + [ENT] [TOUR] + [ENT] [Sensor Number 1~255] + [ALARM] [ALARM] + [ENT] [Monitor Number 1~64] + [MON] [[MON] + [ENT]	Enter CLEAR MODE	⊙	
	Delete Preset position one by one	⊙	
	Clear all Preset positions	⊙	
	Clear all Group	⊙	
	Clear Tour Sequence	⊙	⊙
	Delete Alarm one by one	⊙	⊙
	Clear all Alarms	⊙	⊙
	Delete Monitor one by one	⊙	⊙
	Clear all Monitors	⊙	⊙

